

L450R-06

Blue LED Lamp with UV resistant resin

L450R-06 is an InGaN LED mounted on a lead frame with UV resistant resin.

On forward bias, it emits a band of visible light that peaks 450nm.

This R series is designed for long life under UV wavelength.

◆ Specifications

1) Product Name	Blue LED Lamp
2) Type No.	L450R-06
3) Chip	
(1) Chip Material	InGaN
(2) Peak Wavelength	450nm typ.
4) Package	
(1) Type	Φ5mm clear molding
(2) Resin Material	Silicone Resin
(3) Lead Frame	Soldered (Lead Free)

◆ Outer dimension (Unit: mm)

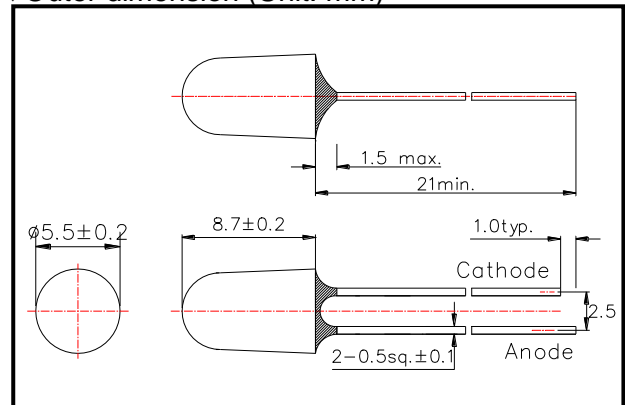

◆ Absolute Maximum Ratings [Ta=25°C]

Item	Symbol	Maximum Rated Value	Unit
Power Dissipation	PD	180	mW
Forward Current	IF	30	mA
Pulse Forward Current	IFP	100	mA
Reverse Voltage	VR	5	V
Thermal Resistance	Rthja	270	K/W
Junction Temperature	Tj	120	°C
Operating Temperature	TOPR	-40 ~ +100	°C
Storage Temperature	TSTG	-40 ~ +100	°C
Soldering Temperature	TSOL	250	°C

‡Pulse Forward Current condition: Duty=1% and Pulse Width=10us.

‡Soldering condition: Soldering condition must be completed within 5 seconds at 250°C

◆ Electro-Optical Characteristics [Ta=25°C typ.]

Item	Symbol	Condition	Minimum	Typical	Maximum	Unit
Forward Voltage	VF	IF=20mA		3.1	4.0	V
	VFP	IFP=100mA		4.4		
Radiated Power	PO	IF=20mA		20		mW
		IFP=100mA		80		
Radiant Intensity	IE	IF=20mA		70		mW/sr
		IFP=100mA		100		
Peak Wavelength	λP	IF=20mA	440	450	460	nm
Half Width	Δλ	IF=20mA		20		nm
Viewing Half Angle	θ 1/2	IF=20mA		±3		deg.

‡Radiated Power is measured by S3584-08.

‡Radiant Intensity is measured by CIE127-2007 Condition B.

Forward Current - Forward Voltage

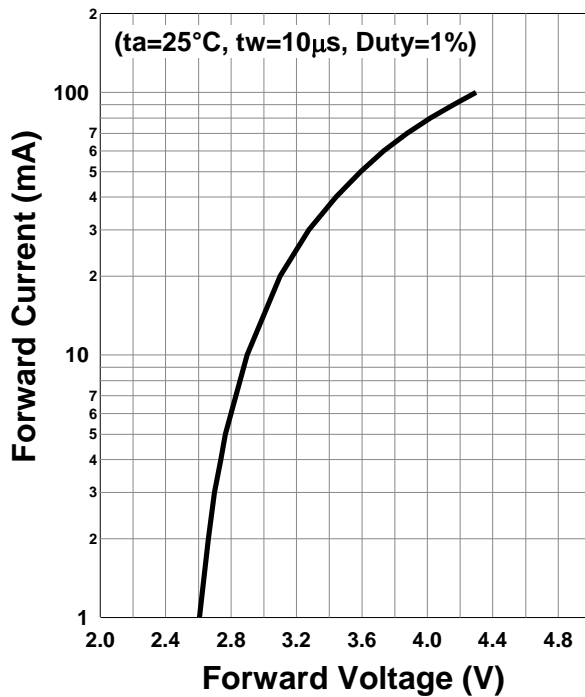

Relative Radiant Intensity - Forward Current

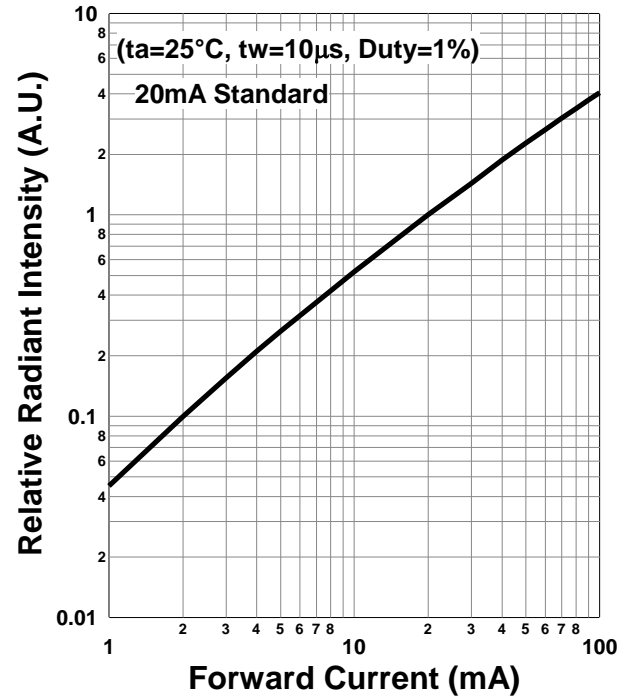

Forward Current - Pulse Duration

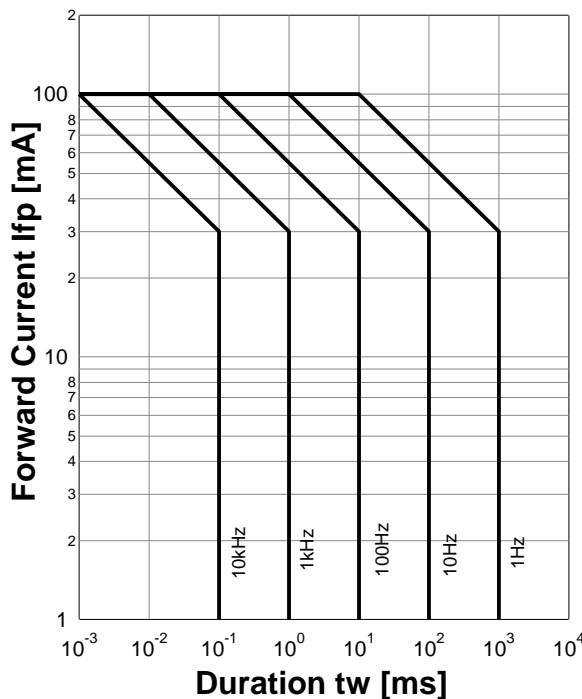

Allowable Forward Current - Ambient Temperature

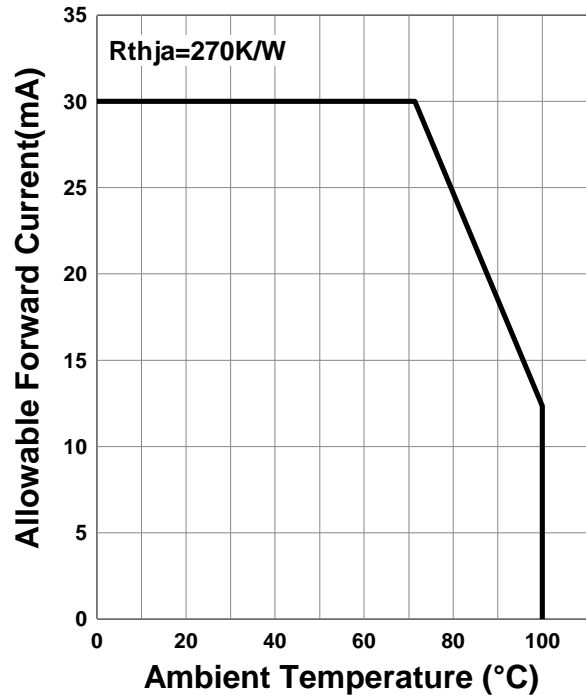

Forward Voltage - Ambient Temperature

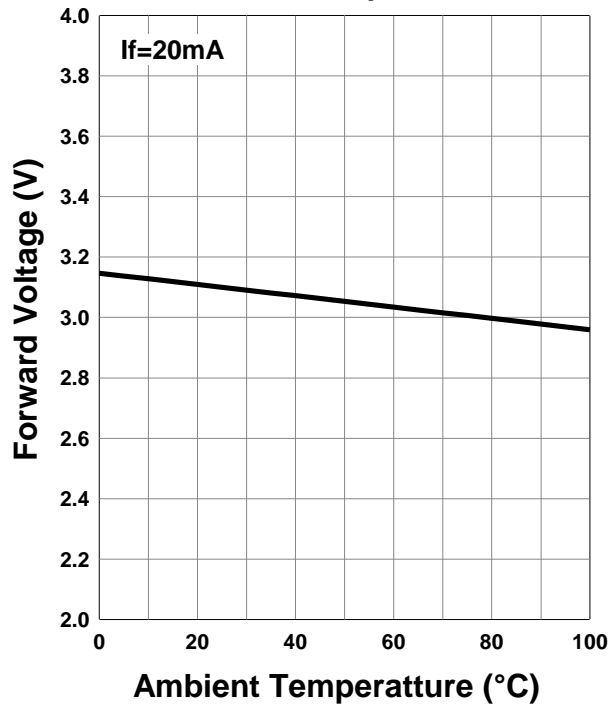

Relative Radiant Intensity - Ambient Temperature

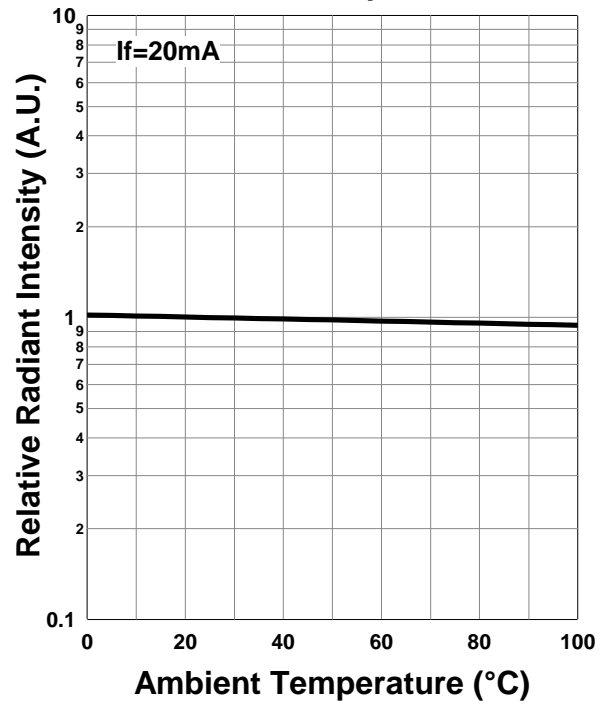

Peak Wavelength - Ambient Temperature

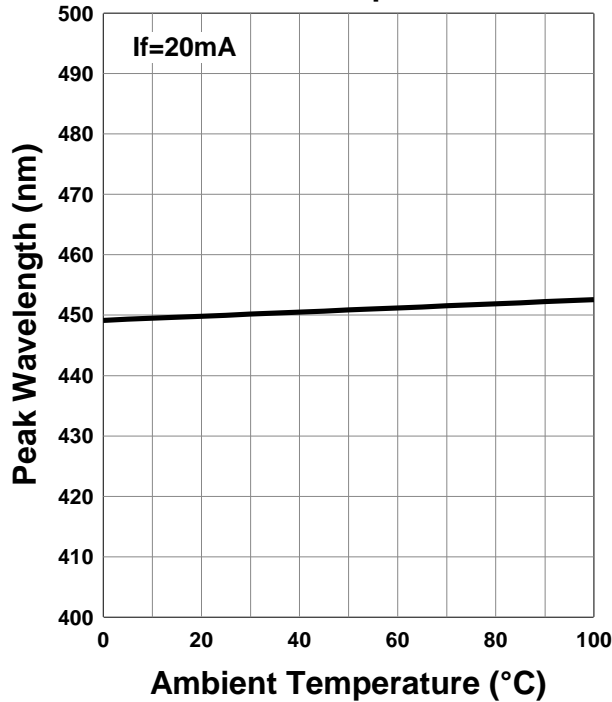

Relative Spectral Emission

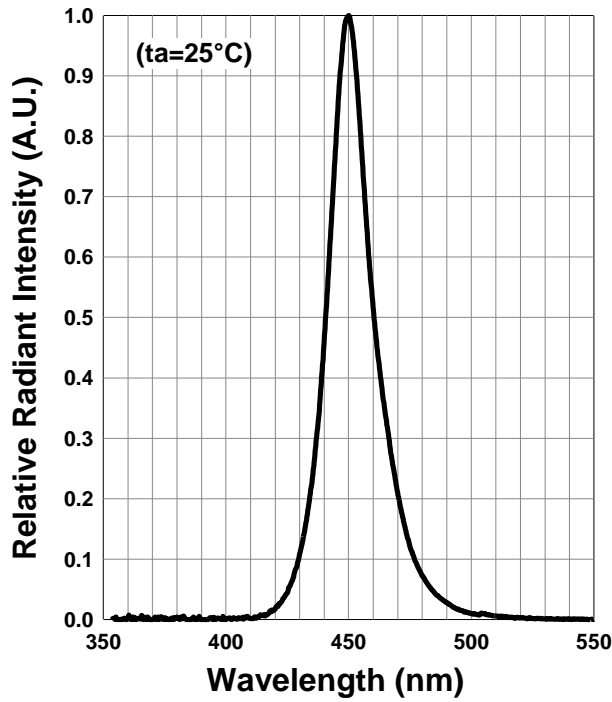

Radiation Characteristics

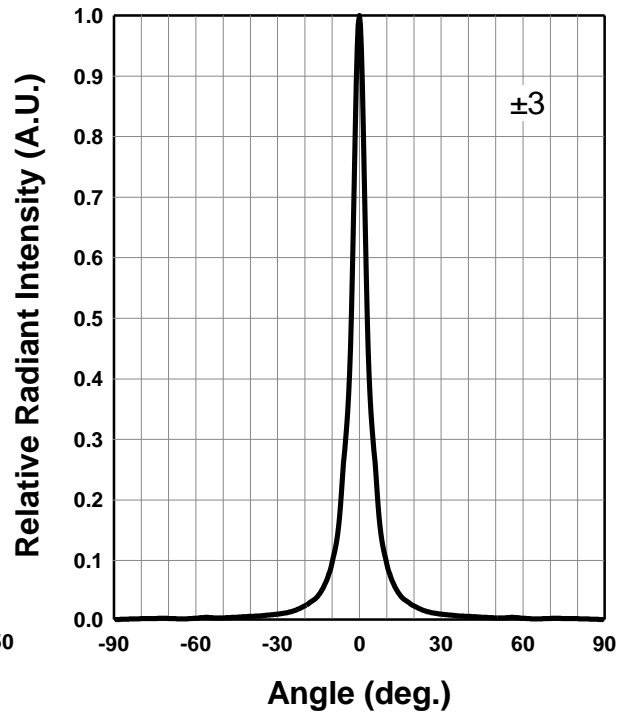

Radiation Characteristics

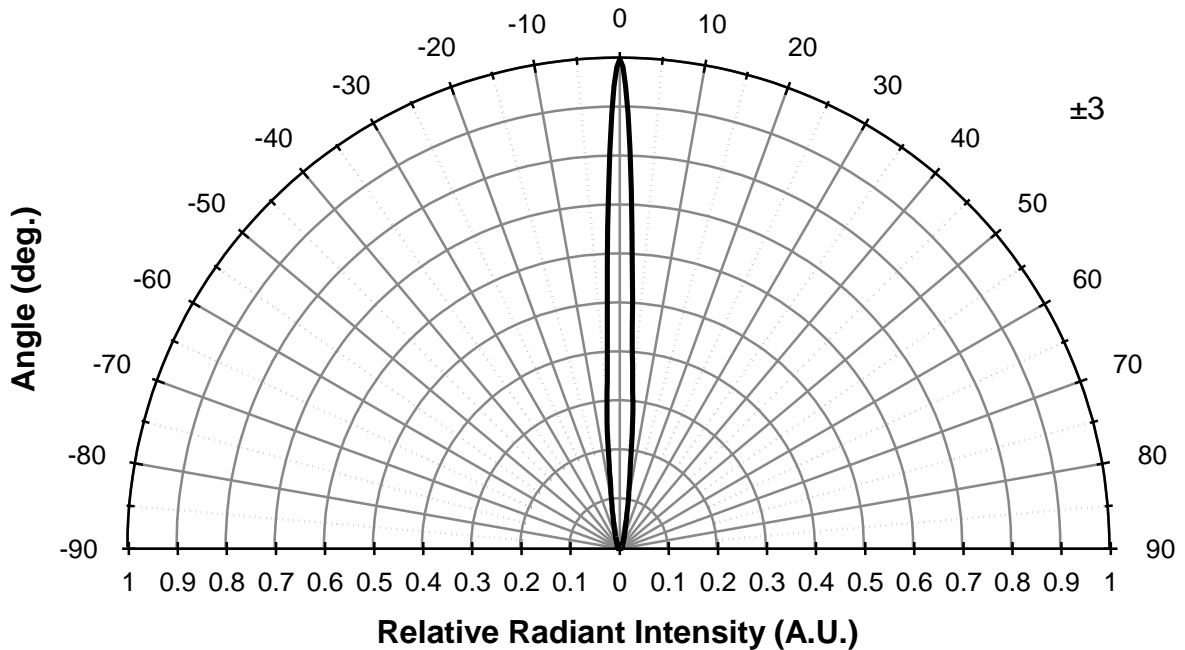

Disclaimer

Product specifications and data shown in this product catalog are subject to change without notice for the purposes of improving product performance, reliability, design, or otherwise.

Product data and parameters in this catalog are typical values based on reasonably up-to-date measurements. Product data and parameters may vary by user application and over time.

Products shown in this catalog are intended to be used for general electronic equipment. Products are not guaranteed for applications where product malfunction or failure may cause personal injury or death, including but not limited to life-supporting / saving devices, medical devices, safety devices, airplanes, aerospace equipment, automobiles, traffic control systems, and nuclear reactor control systems.