

L940D-34

Infrared LED Lamp

L940D-34 is an AlGaAs LED mounted on a lead frame with a clear epoxy lens. On forward bias it emits a spectral band of radiation, which peaks at 940nm.

◆ Specifications

- 1) Product Name Infrared LED Lamp
- 2) Type No. L940D-34
- 3) Chip
- (1) Chip Material AlGaAs
- (2) Peak Wavelength 940nm typ.
- 4) Package
- (1) Type Φ3mm clear molding
- (2) Resin Material Epoxy Resin
- (3) Lead Frame Soldered (Lead Frame)

◆ Outer dimension (Unit: mm)

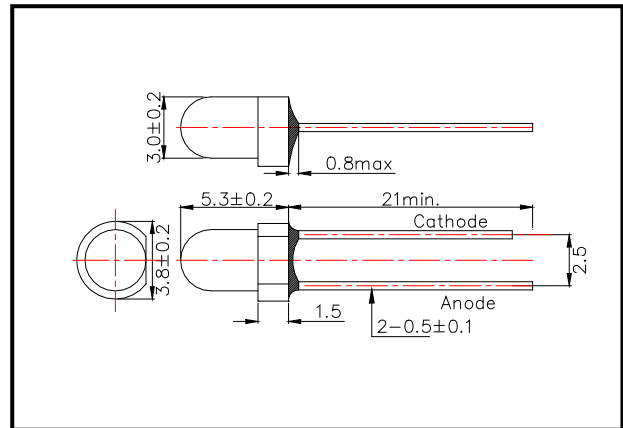

◆ Absolute Maximum Ratings [Ta=25°C]

Item	Symbol	Maximum Rated Value	Unit
Power Dissipation	P _D	170	mW
Forward Current	I _F	100	mA
Pulse Forward Current	I _{FP}	1000	mA
Reverse Voltage	V _R	5	V
Thermal Resistance	R _{thja}	180	K/W
Junction Temperature	T _j	120	°C
Operating Temperature	T _{OPR}	-40 ~ +100	°C
Storage Temperature	T _{STG}	-40 ~ +100	°C
Soldering Temperature	T _{SOL}	250	°C

‡Pulse Forward Current condition: Duty=1% and Pulse Width=10us.

‡Soldering condition: Soldering condition must be completed within 5 seconds at 250°C

◆ Electro-Optical Characteristics [Ta=25°C typ.]

Item	Symbol	Condition	Minimum	Typical	Maximum	Unit
Forward Voltage	V _F	I _F =50mA		1.5	1.7	V
Radiated Power	P _o	I _F =50mA		25		mW
Total Radiated Power	I _E	I _F =50mA		110		mcd
Peak Wavelength	λ _P	I _F =50mA		940		nm
Half Width	Δλ	I _F =50mA		40		nm
Viewing Half Angle	θ _{1/2}	I _F =50mA		±5		deg.
Rise Time	t _r	I _F =50mA		22		ns
Fall Time	t _f	I _F =50mA		25		ns

‡Radiated Power is measured by S3584-08.

‡Radiant Intensity is measured by CIE127-2007 Condition B.

Forward Current - Forward Voltage

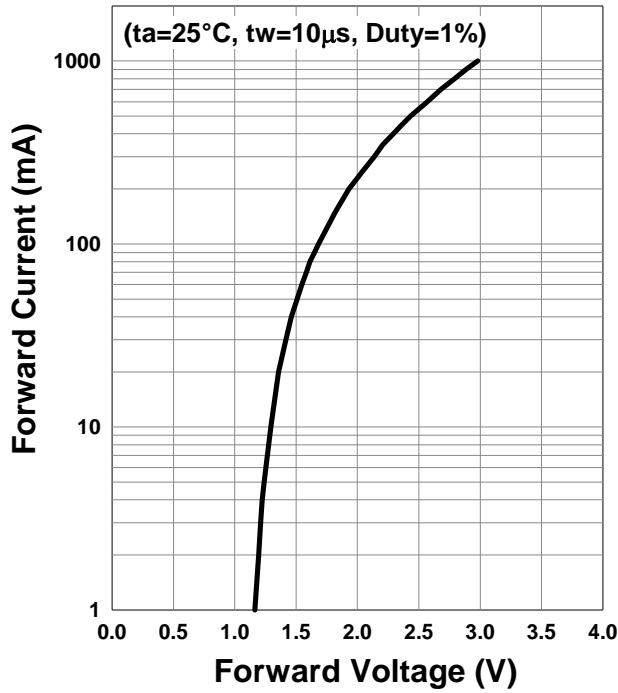

Relative Radiant Intensity - Forward Current

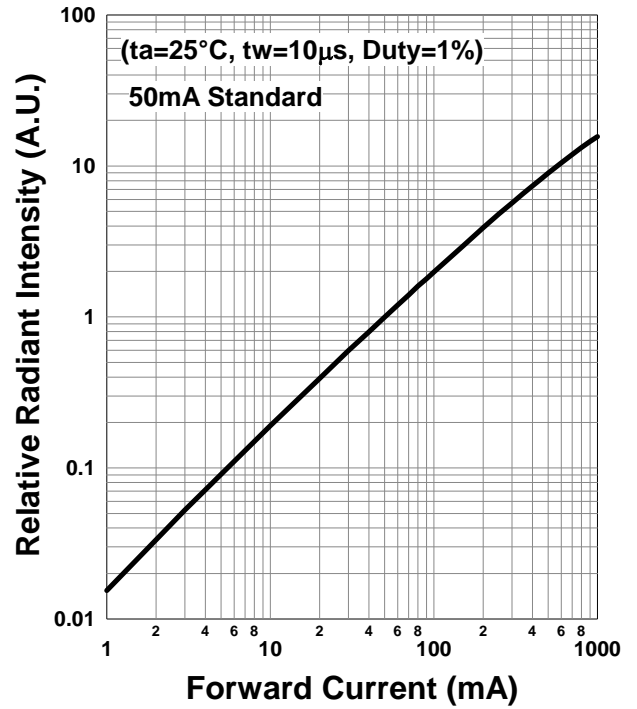

Forward Current - Pulse Duration

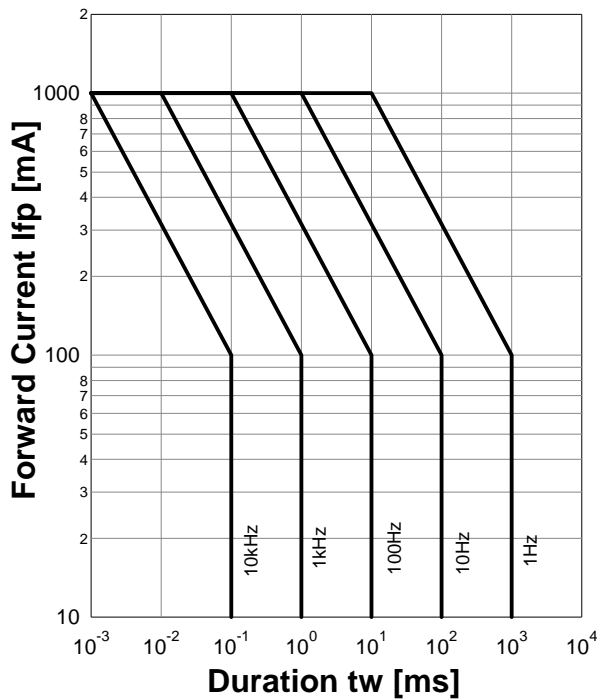

Allowable Forward Current - Ambient Temperature

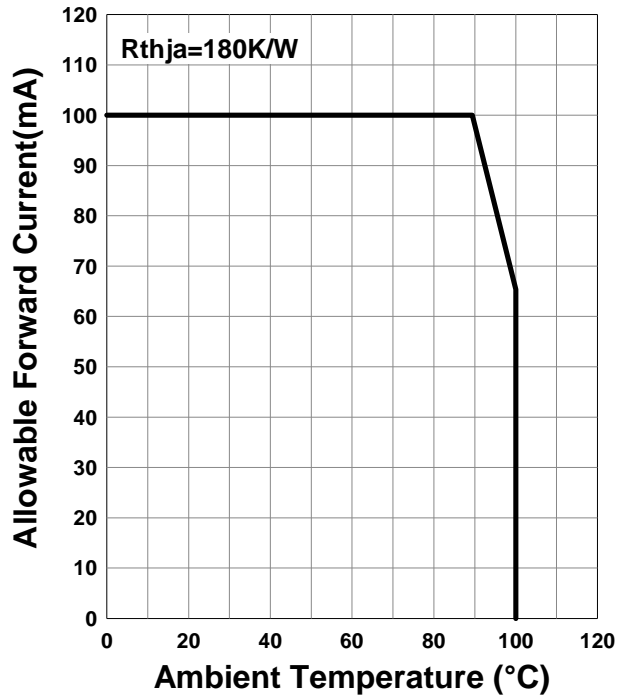

Forward Voltage - Ambient Temperature

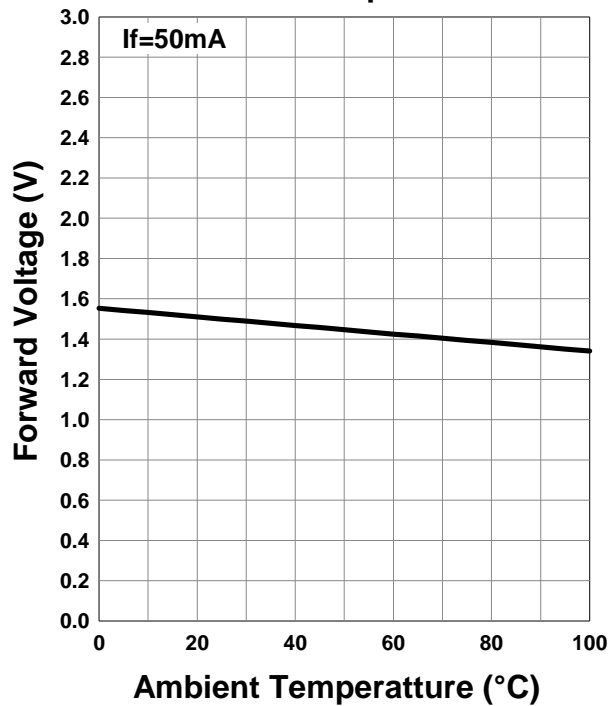

Relative Radiant Intensity - Ambient Temperature

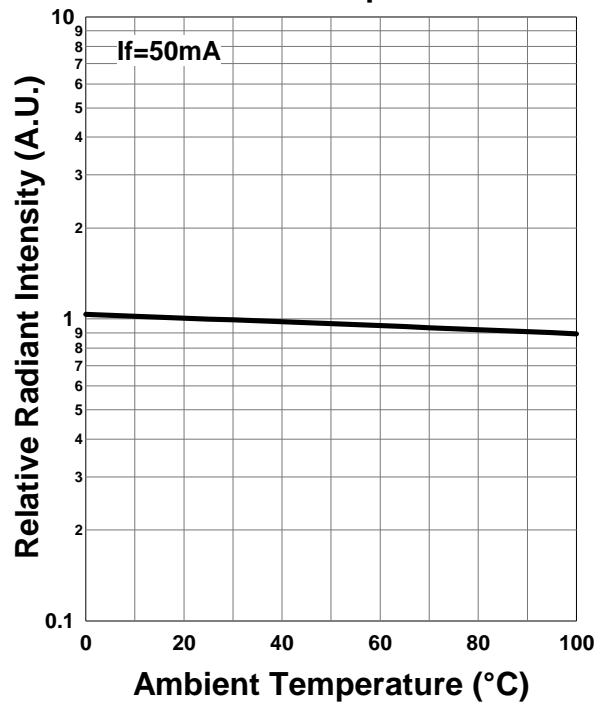

Peak Wavelength - Ambient Temperature

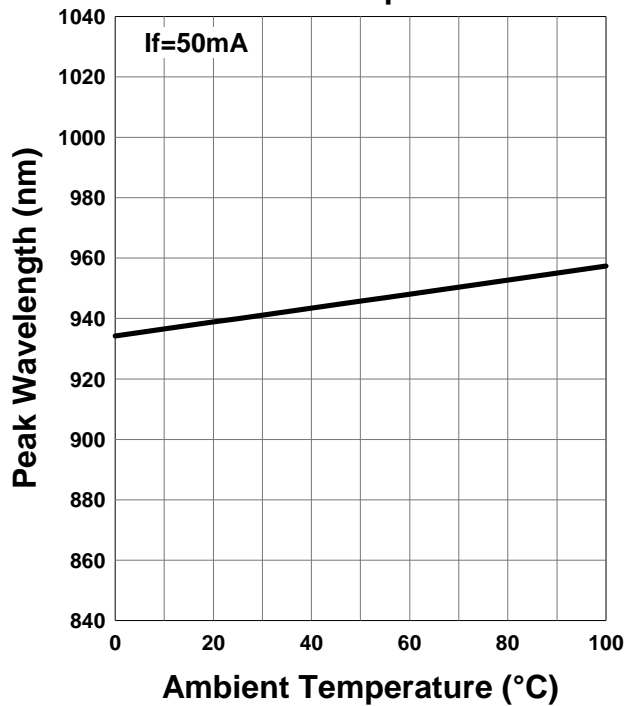

Relative Spectral Emission

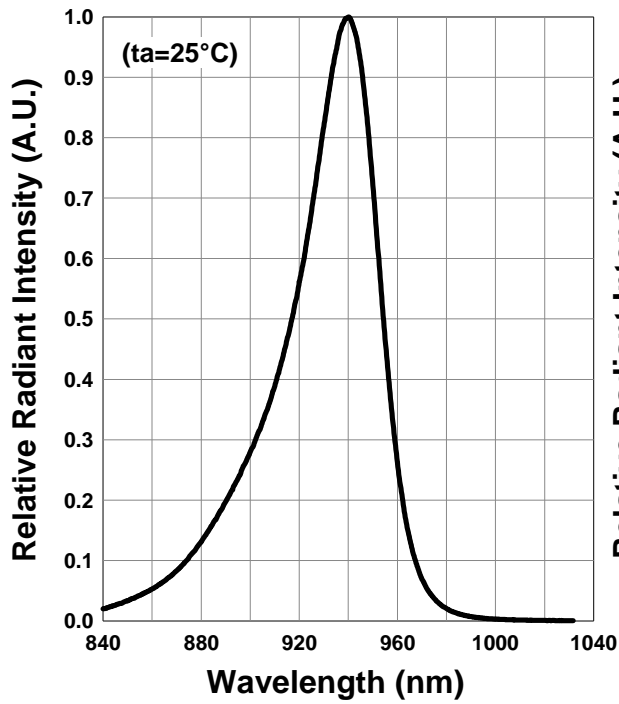

Radiation Characteristics

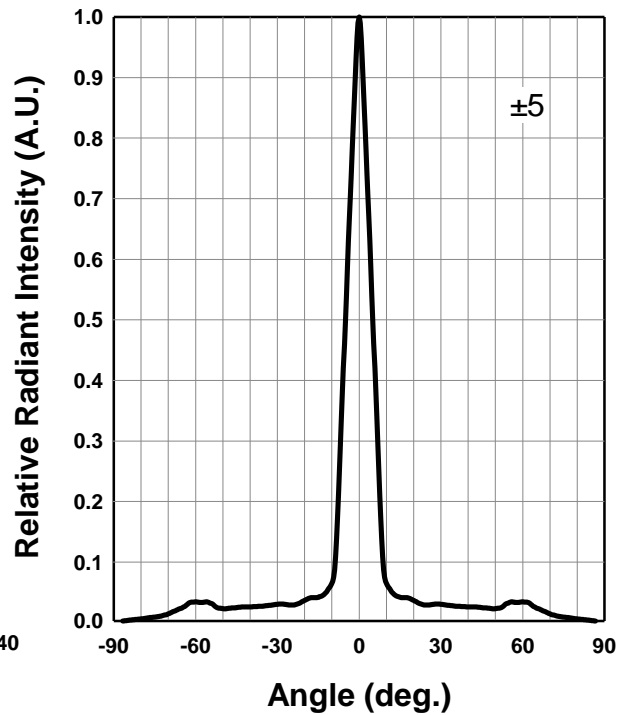

Radiation Characteristics

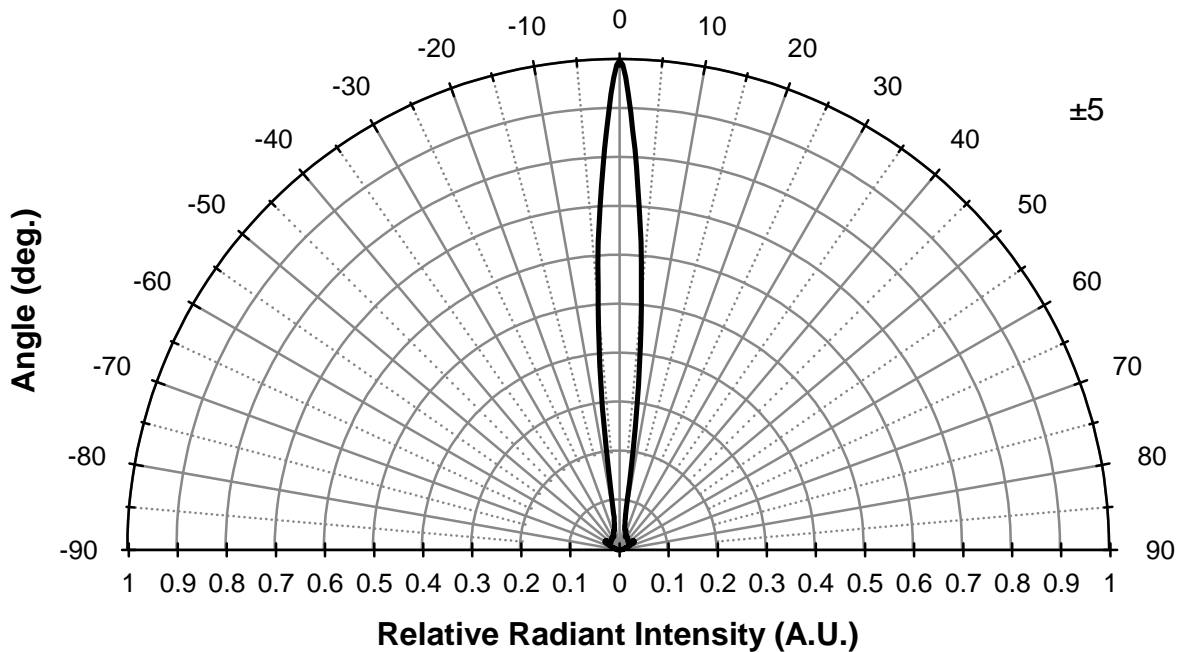

Disclaimer

Product specifications and data shown in this product catalog are subject to change without notice for the purposes of improving product performance, reliability, design, or otherwise.

Product data and parameters in this catalog are typical values based on reasonably up-to-date measurements. Product data and parameters may vary by user application and over time.

Products shown in this catalog are intended to be used for general electronic equipment. Products are not guaranteed for applications where product malfunction or failure may cause personal injury or death, including but not limited to life-supporting / saving devices, medical devices, safety devices, airplanes, aerospace equipment, automobiles, traffic control systems, and nuclear reactor control systems.