

L690-40K42 stem type LED with high beam

L690-40K42 is AlGaAs LED mounted on TO-46 stem with unspherical glass lens, being designed for high beam uses.

On forward bias, it emits a spectral band of radiation, which peaks at 690nm.

◆ Outer dimension (Unit:mm)

◆ Features

- 1) High radiated intensity
- 2) High Reliability

◆ Specifications

- 1) Product Name Infrared LED Lamp
- 2) Type No. L690-40K42
- 3) Chip Spec.
- (1) Material AlGaAs
- (2) Peak Wavelength 690nm
- 4) Package
- (1) Type TO-46 stem
- (2) Lens Unspherical glass lens
- (3) Cap Gold plated

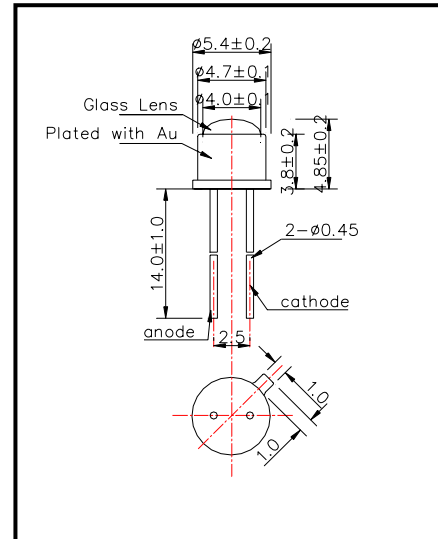

◆ Absolute Maximum Ratings

Item	Symbol	Maximum Rated Value	Unit	Ambient Temperature
Power Dissipation	P _D	110	mW	T _a =25°C
Forward Current	I _F	50	mA	T _a =25°C
Pulse Forward Current	I _{FP}	200	mA	T _a =25°C
Reverse Voltage	V _R	5	V	T _a =25°C
Operating Temperature	T _{OPR}	-30 ~ +80	°C	
Storage Temperature	T _{STG}	-30 ~ +100	°C	
Soldering Temperature	T _{SOL}	260	°C	

‡Pulse Forward Current condition: Duty=1% and Pulse Width=10us.

‡Soldering condition: Soldering condition must be completed within 3 seconds at 260°C

◆ Electro-Optical Characteristics

Item	Symbol	Condition	Minimum	Typical	Maximum	Unit
Forward Voltage	V _F	I _F =20mA		1.90	2.30	V
Reverse Current	I _R	V _R =5V			10	uA
Total Radiated Power	P _O	I _F =20mA		2.5		mW
Radiant Intensity	I _E	I _F =20mA		18		mW/sr
Peak Wavelength	λ _P	I _F =20mA	670	690	710	nm
Half Width	Δλ	I _F =20mA		20		nm
Viewing Half Angle	θ _{1/2}	I _F =20mA		±6		deg.
Rise Time	t _r	I _F =20mA		80		ns
Fall Time	t _f	I _F =20mA		80		ns

‡Total Radiated Power is measured by Photodyne #500

‡Radiant Intensity is measured by Tektronix J-6512.