

L750-40K00 stem type LED with epoxy resin lens

L750-40K00 is AlGaAs LED mounted on TO-46 stem with epoxy resin lens, being designed for wide viewing angle.

On forward bias, it emits a spectral band of radiation, which peaks at 750nm

◆ Features

- 1) Wide viewing angle
- 2) High Reliability

◆ Specifications

- 1) Product Name Infrared LED Lamp
- 2) Type No. L750-40K00
- 3) Chip Spec.
 - (1) Material AlGaAs
 - (2) Peak Wavelength 750nm
- 4) Package
 - (1) Type TO-46 stem
 - (2) Lens Epoxy resin lens
 - (3) Cap Gold plated

◆ Outer dimension(Unit:mm)

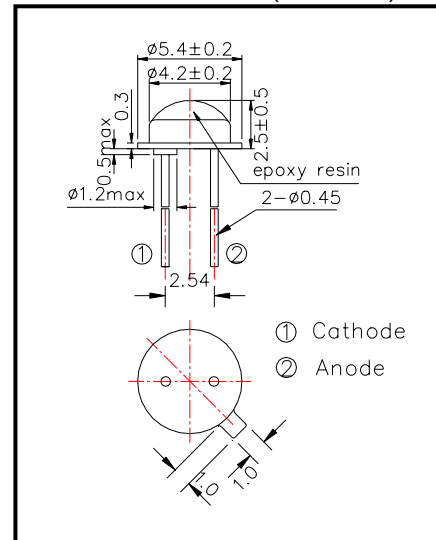

◆ Absolute Maximum Ratings

Item	Symbol	Maximum Rated Value	Unit	Ambient Temperature
Power Dissipation	P_D	200	mW	$T_a=25^\circ\text{C}$
Forward Current	I_F	100	mA	$T_a=25^\circ\text{C}$
Pulse Forward Current	I_{FP}	500	mA	$T_a=25^\circ\text{C}$
Reverse Voltage	V_R	5	V	$T_a=25^\circ\text{C}$
Operating Temperature	T_{OPR}	-30 ~ +90	$^\circ\text{C}$	
Storage Temperature	T_{STG}	-30 ~ +100	$^\circ\text{C}$	
Soldering Temperature	T_{SOL}	260	$^\circ\text{C}$	

‡Pulse Forward Current condition: Duty=1% and Pulse Width=10us.

‡Soldering condition: Soldering condition must be completed within 3 seconds at 260°C

◆ Electro-Optical Characteristics

Item	Symbol	Condition	Minimum	Typical	Maximum	Unit
Forward Voltage	V_F	$I_F=20\text{mA}$		1.85	2.00	V
Reverse Current	I_R	$V_R=5\text{V}$			10	μA
Total Radiated Power	P_O	$I_F=20\text{mA}$	9.0	16.0		mW
Radiant Intensity	I_E	$I_F=20\text{mA}$		6		mW/sr
Peak Wavelength	λ_P	$I_F=20\text{mA}$	730	750	770	nm
Half Width	$\Delta\lambda$	$I_F=20\text{mA}$		30		nm
Viewing Half Angle	$\theta_{1/2}$	$I_F=20\text{mA}$		± 40		deg.
Rise Time	t_r	$I_F=20\text{mA}$		150		ns
Fall Time	t_f	$I_F=20\text{mA}$		150		ns

‡Total Radiated Power is measured by Photodyne #500

‡Radiant Intensity is measured by Tektronix J-6512.