

L810-40M00

Stem type LED with epoxy lens

L810-40M00 is an AlGaAs LED mounted on TO-18 stem with epoxy resin lens, being designed for wide viewing angle.

On forward bias it emits a spectral band of radiation, which peaks at 810nm.

◆ Features

- 1) Wide viewing angle
- 2) High Reliability

◆ Specifications

- 1) Product Name Infrared LED Lamp
- 2) Type No. L810-40M00
- 3) Chip Spec.
 - (1) Material AlGaAs
 - (2) Peak Wavelength 810nm
- 4) Package
 - (1) Type TO-18 stem
 - (2) Lens Epoxy resin

◆ Outer dimension (Unit:mm)

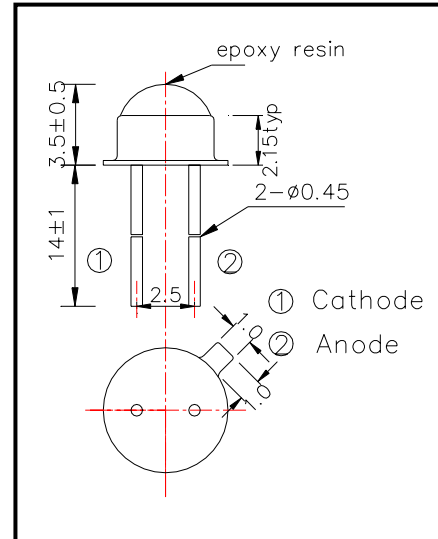

◆ Absolute Maximum Ratings

Item	Symbol	Maximum Rated Value	Unit	Ambient Temperature
Power Dissipation	P _D	170	mW	T _a =25°C
Forward Current	I _F	100	mA	T _a =25°C
Pulse Forward Current	I _{FP}	500	mA	T _a =25°C
Reverse Voltage	V _R	5	V	T _a =25°C
Operating Temperature	T _{OPR}	-30 ~ +90	°C	
Storage Temperature	T _{STG}	-30 ~ +100	°C	
Soldering Temperature	T _{SOL}	260	°C	

‡Pulse Forward Current condition: Duty=1% and Pulse Width=10us.

‡Soldering condition: Soldering condition must be completed within 3 seconds at 260°C

◆ Electro-Optical Characteristics

Item	Symbol	Condition	Minimum	Typical	Maximum	Unit
Forward Voltage	V _F	I _F =50mA		1.60	1.80	V
Reverse Current	I _R	V _R =5V			10	uA
Total Radiated Power	P _O	I _F =50mA	11	18		mW
Radiant Intensity	I _E	I _F =50mA		10		mW/sr
Peak Wavelength	λ _P	I _F =50mA	790	810	830	nm
Half Width	Δλ	I _F =50mA		35		nm
Viewing Half Angle	θ _{1/2}	I _F =50mA		±40		deg.
Rise Time	t _r	I _F =50mA		60		ns
Fall Time	t _f	I _F =50mA		40		ns

‡Total Radiated Power is measured by Photodyne #500

‡Radiant Intensity is measured by Tektronix J-6512.